



THE **FFA** ltd.

[www.theffa.co.uk](http://www.theffa.co.uk)

**FURNITURE**

**FITTINGS**

**ACCESSORIES**





We at FFA ( furniture-fittings-accessories) specialise in providing excellent products in premium finish. We use the best available materials such as solid wood, exotic wood veneers and also offer the choice of 980 colour finishes.

Whether you are a developer, architect, carpenter, designer or an individual client, we can make sure that the product you order from us will be of the highest quality at best possible price.

FFA manufacture and supply kitchens, wardrobes which you can select from our catalogue. We will be happy to assist with more bespoke requirements as well. Our range of acoustic and decorative panels is stunning and comes in various sizes and finishes. Order your ironmongery products from our website.

We supply brands such as Blum, Hettich, Strong and many more.

With us you are in good hands as our focus is always on quality and excellence of craftsmanship which reflects our passion for well built furniture.

page 3: List

page 4-49: Complete kitchens

(page 4-7) 2. LR

(page 8-19) 4. WRW

LRW

LRS

(page 20-25) 10. WO

(page 26-33) 14. WOK

L2K

(page 32-37) 18. DS

(page 38-42) 22. DQ

(page 43-47) 26. SMQ

page 48-50: Wardrobes

page 51-65: Acoustic panels

page 66-68: Ironmongery

page 69: Company details,  
Contacts

Model  
LR

LACQUERED





ZK



CS



CG



DP

# LR

## TECHNICAL CARD



RIBBED FRONT PANEL MADE OF  
MDF BOARD FINISHED WITH  
RAL / NCS PALETTE MATT LAQUER  
VERTICAL MILLING DIRECTION

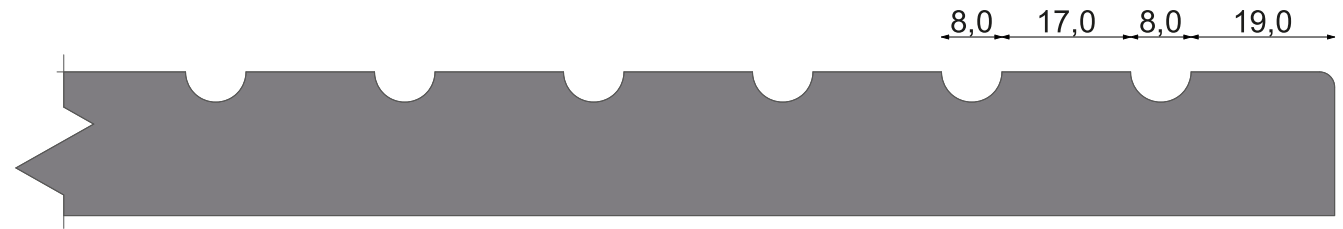

DETAIL \_ SECTION

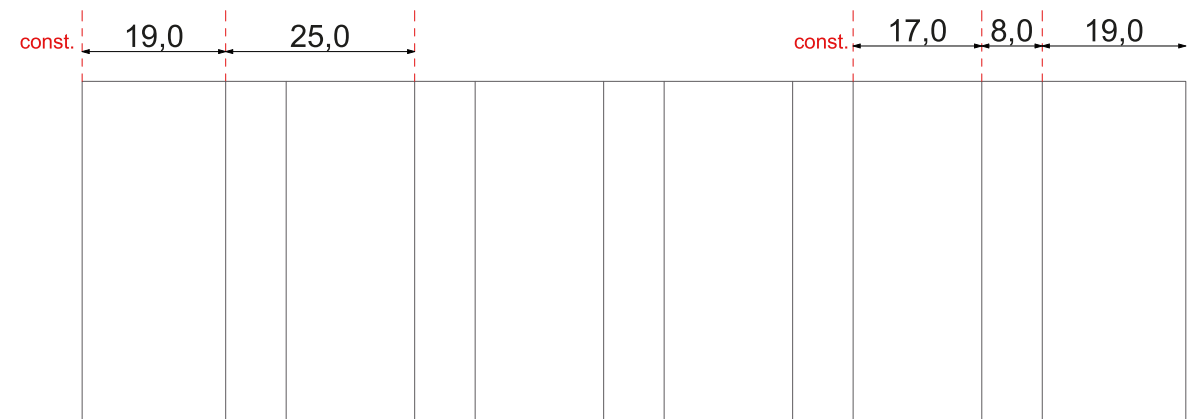

RULES\_STANDARD DIMENSIONS

FOR COMPONENTS WITH DIMENSIONS GREATER THAN 1200mm, IT IS RECOMMENDED TO USE AN LEVELING MECHANISM

ZK



HEIGHT: 96 - 2100  
WIDTH: 96 - 700

CS



HEIGHT: 96 - 252  
WIDTH: 96 - 1000

CG

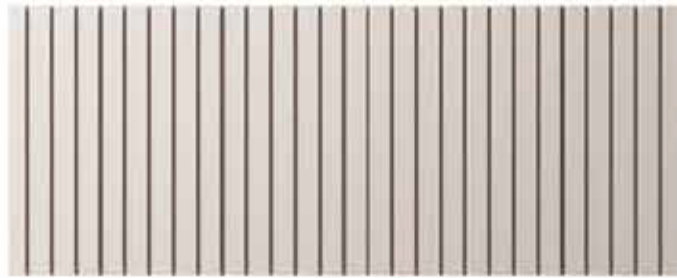

HEIGHT: 96 - 400  
WIDTH: 96 - 1000

DP



HEIGHT: 401 - 2100  
WIDTH: 96 - 700

Model

WRW

WRS

VENEER/WOOD

Model

LRW

LRS

LACQUERED









DN.n-000      DN.b-009      DN.b-010      DN.b-017      DN.b-020



ON.n-000      ON.b-001      ON.b-007





RIBBED FRONT PANEL MADE OF  
MDF BOARD FINISHED WITH  
RAL / NCS PALETTE LAQUER  
VERTICAL MILLING DIRECTION

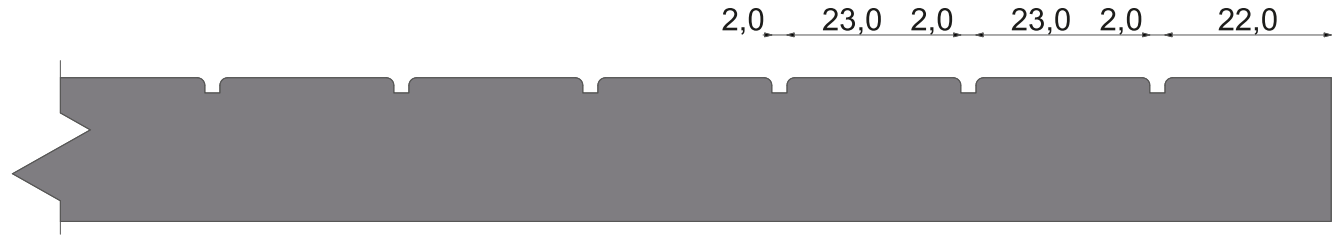

DETAIL\_SECTION

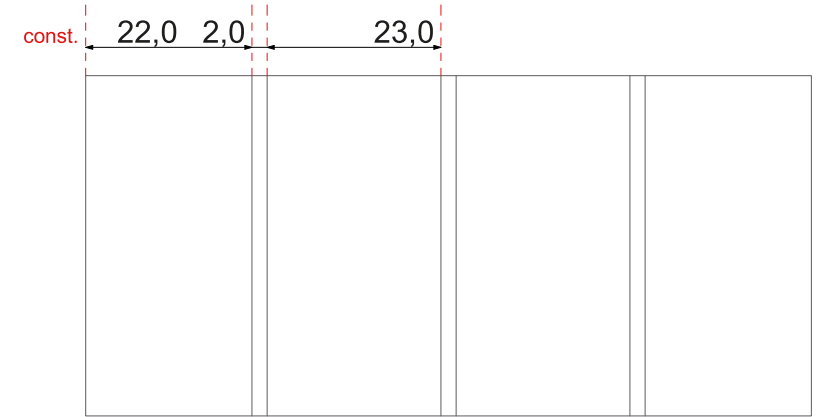
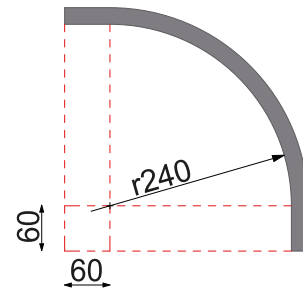

RULES\_STANDARD DIMENSIONS

FOR COMPONENTS WITH DIMENSIONS GREATER THAN 1200mm, IT IS RECOMMENDED TO USE AN LEVELING MECHANISM

ZK



HEIGHT: 96 - 2100  
WIDTH: 96 - 700

DG\*



HEIGHT: 96 - 1200  
WIDTH: 546!

CS



HEIGHT: 96 - 252  
WIDTH: 96 - 1000

CG



HEIGHT: 96 - 400  
WIDTH: 96 - 1000

DP



HEIGHT: 401 - 2100  
WIDTH: 96 - 700



RIBBED FRONT PANEL MADE OF  
MDF BOARD FINISHED WITH  
RAL / NCS PALETTE LAQUER  
VERTICAL MILLING DIRECTION



/DETAIL\_SECTION

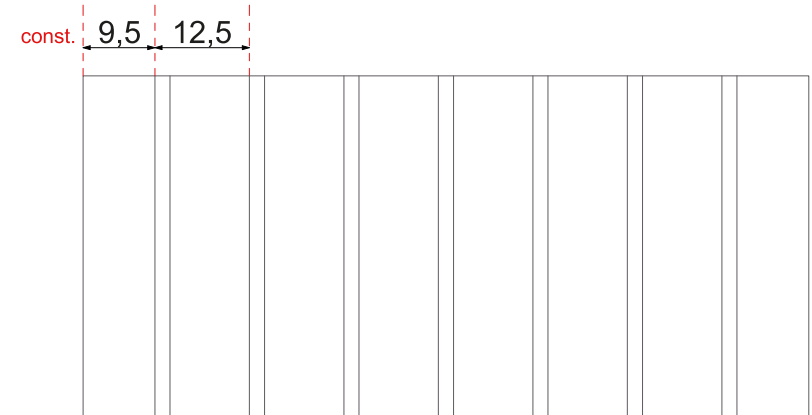
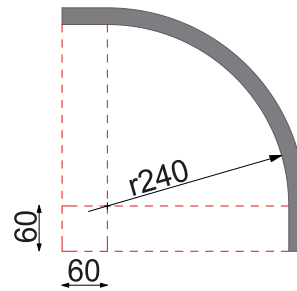

RULES\_STANDARD DIMENSIONS

FOR COMPONENTS WITH DIMENSIONS GREATER THAN 1200mm, IT IS RECOMMENDED TO USE AN LEVELING MECHANISM

ZK



HEIGHT: 96 - 2100  
WIDTH: 96 - 700

DG



HEIGHT: 96 - 1200  
WIDTH: 546!

CS



HEIGHT: 96 - 252  
WIDTH: 96 - 1000

CG



HEIGHT: 96 - 400  
WIDTH: 96 - 1000

DP



HEIGHT: 401 - 2100  
WIDTH: 96 - 700



# LRS

## TECHNICAL CARD

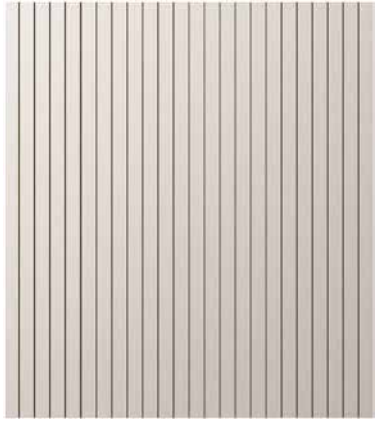

RIBBED FRONT PANEL MADE OF  
MDF BOARD FINISHED WITH  
RAL / NCS PALETTE MATT LAQUER  
VERTICAL MILLING DIRECTION

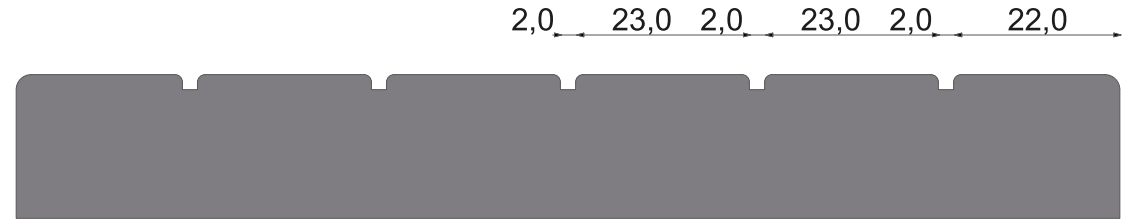

DETAIL \_ SECTION

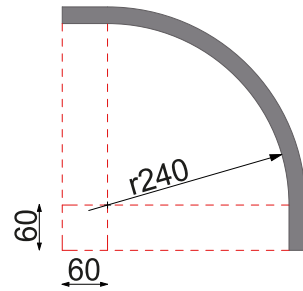

RULES\_STANDARD DIMENSIONS

FOR COMPONENTS WITH DIMENSIONS GREATER THAN 1200mm, IT IS RECOMMENDED TO USE AN LEVELING MECHANISM



ZK



HEIGHT: 96 - 2100  
WIDTH: 96 - 700

DG

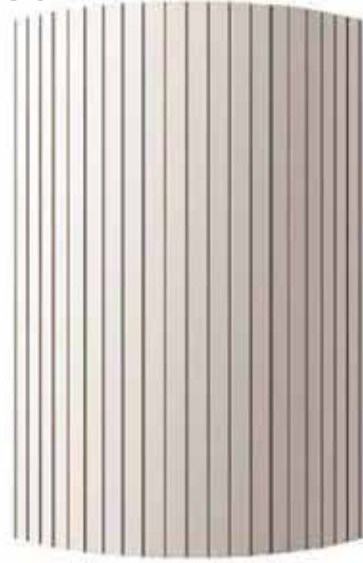

HEIGHT: 96 - 1200  
WIDTH: 546!

CS



HEIGHT: 96 - 252  
WIDTH: 96 - 1000

CG



HEIGHT: 96 - 400  
WIDTH: 96 - 1000

DP



HEIGHT: 401 - 2100  
WIDTH: 96 - 700

# LRW

## TECHNICAL CARD

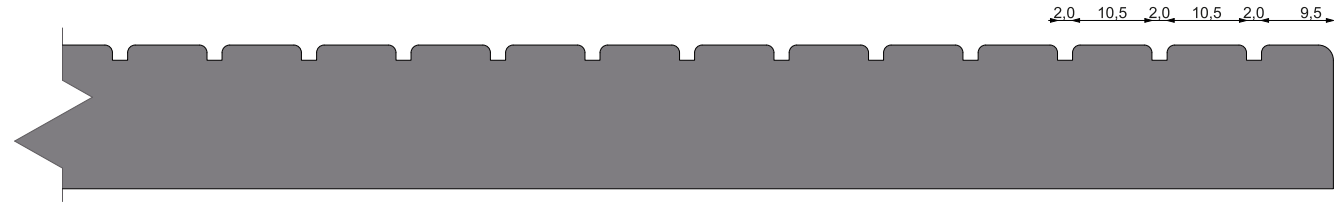
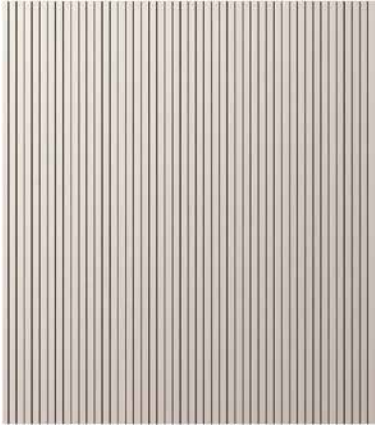

DETAIL\_SECTION

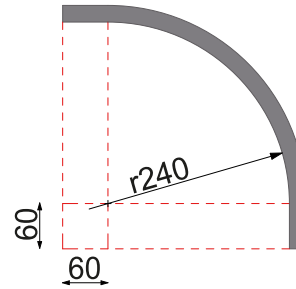

RIBBED FRONT PANEL MADE OF  
MDF BOARD FINISHED WITH  
RAL / NCS PALETTE MATT LAQUER  
VERTICAL MILLING DIRECTION

RULES\_STANDARD DIMENSIONS

FOR COMPONENTS WITH DIMENSIONS GREATER THAN 1200mm, IT IS RECOMMENDED TO USE AN LEVELING MECHANISM

ZK



HEIGHT: 96 - 2100  
WIDTH: 96 - 700

DG

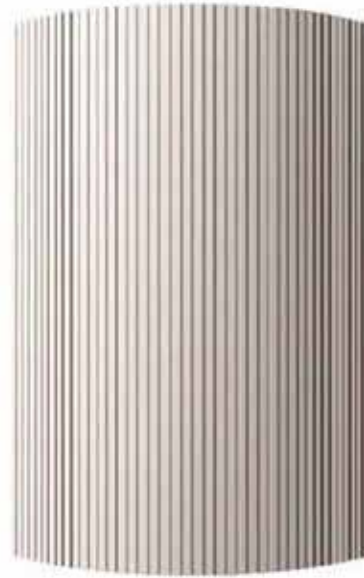

HEIGHT: 96 - 1200  
WIDTH: 546!

CS



HEIGHT: 96 - 252  
WIDTH: 96 - 1000

CG

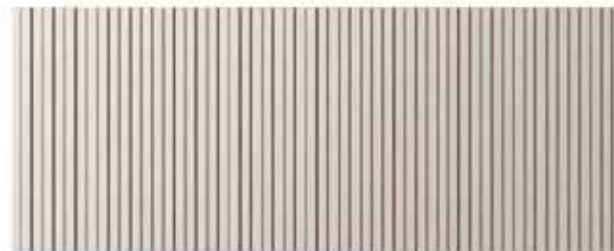

HEIGHT: 96 - 400  
WIDTH: 96 - 1000

DP



HEIGHT: 401 - 2100  
WIDTH: 96 - 700







ZK



CS



CG



DP



WO



DG

# W/O

## TECHNICAL CARD

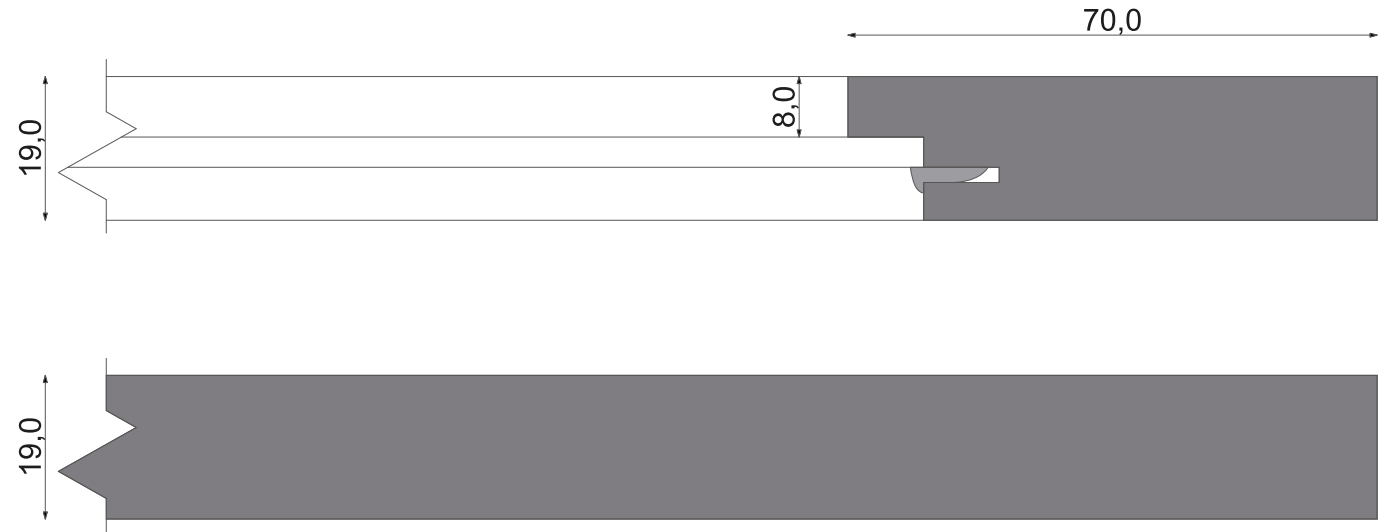

DETAIL\_SECTION

FLAT FRONT PANEL MADE OF  
VENEERED MDF BOARD FINISHED  
WITH TRANSPARENT OR COLOURED  
MATT LAQUER  
VERTICAL DIRECTION FOR GRAIN

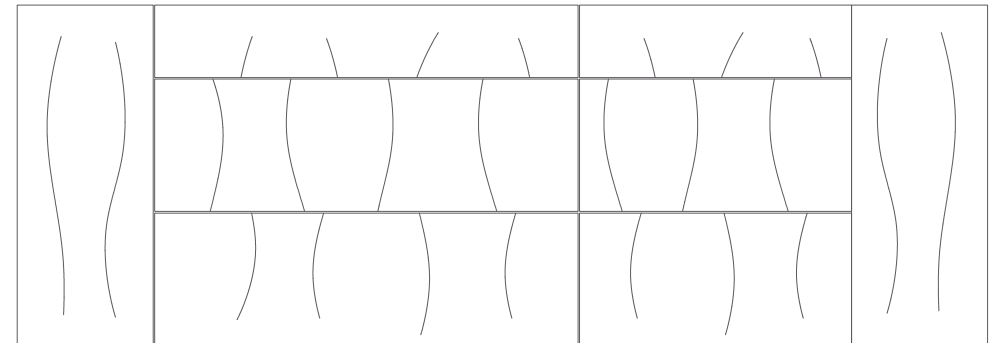
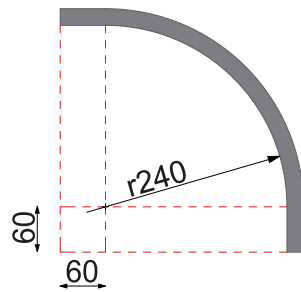

RULES\_STANDARD DIMENSIONS

FOR COMPONENTS WITH DIMENSIONS GREATER THAN 1200mm, IT IS RECOMMENDED TO USE AN LEVELING MECHANISM

WO

ZK



HEIGHT: 96 - 2100  
WIDTH: 96 - 700

CS



HEIGHT: 96 - 252  
WIDTH: 96 - 1000

CG



HEIGHT: 96 - 400  
WIDTH: 96 - 1000

# TECHNICAL CARD

DG\*



HEIGHT: 96 - 1200  
WIDTH: 546!

WO



HEIGHT: 401 - 1500  
WIDTH: 296 - 700

DR



HEIGHT: 401 - 2100  
WIDTH: 96 - 700





# Model WOK

LACQUERED

# Model L2K

VENEER/LACQUERED



# WOK

## TECHNICAL CARD

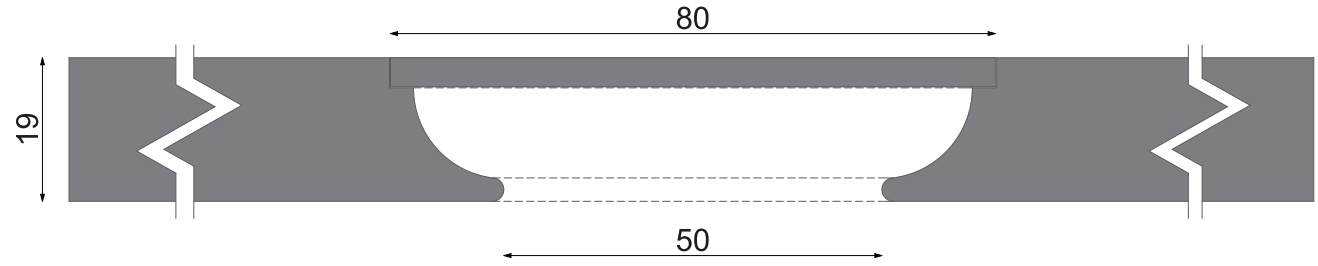

DETAIL\_SECTION

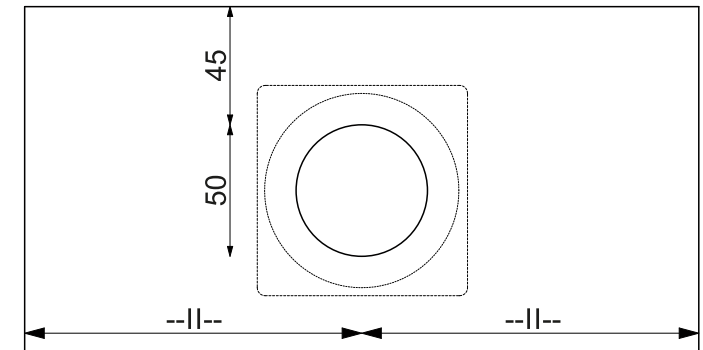
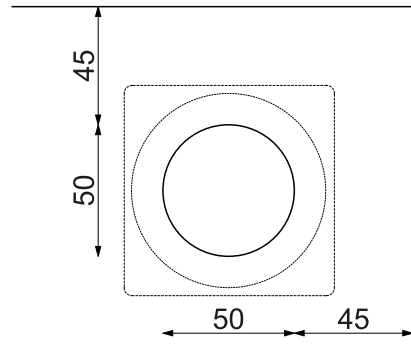

DETAIL\_HANDLE LOCATION

FLAT FRONT PANEL MADE OF VENEERED MDF BOARD WITH MILLED HANDLE AND INSERT. VERTICAL DIRECTION FOR GRAIN. FINISHED WITH TRANSPARENT OR COLOURED MATT LAQUER.

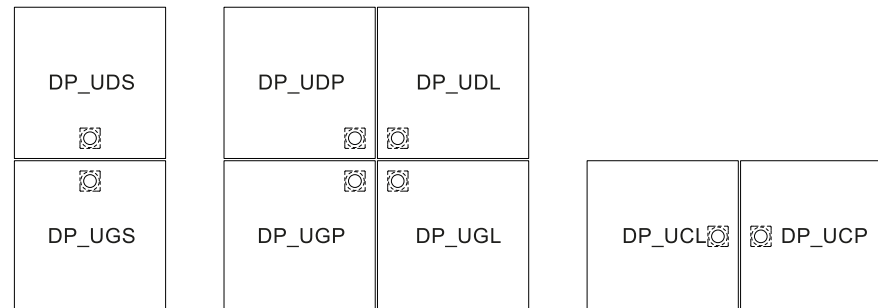

FRONT ASSEMBLING EXAMPLES

FOR COMPONENTS WITH DIMENSIONS GREATER THAN 1200mm, IT IS RECOMMENDED TO USE AN LEVELING MECHANISM



ZK



HEIGHT: 96 - 2100  
WIDTH: 96 - 700

CS



HEIGHT 140 - 252  
WIDTH: 236 - 1000

CG



HEIGHT: 253 - 400  
WIDTH: 236 - 1000

DP\_UGP



HEIGHT: 401 - 2100  
WIDTH: 236 - 700

DP\_UGS



HEIGHT: 401 - 2100  
WIDTH: 236 - 700

DP\_UGL



HEIGHT: 401 - 2100  
WIDTH: 236 - 700

DP\_UDP



HEIGHT: 401 - 2100  
WIDTH: 236 - 700

DP\_UDS



HEIGHT: 401 - 2100  
WIDHT: 236 - 700

DP\_UDL



HEIGHT: 401 - 2100  
WIDTH: 236 - 700

DP\_UCP



HEIGHT: 401 - 2100  
WIDTH: 236 - 700

DP\_UCL



HEIGHT 401 - 2100  
WIDTH: 236 - 700

# L2K

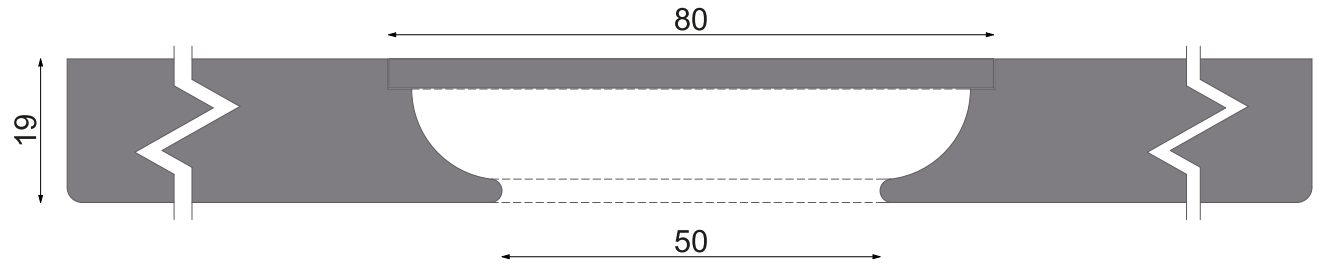

DETAIL\_SECTION

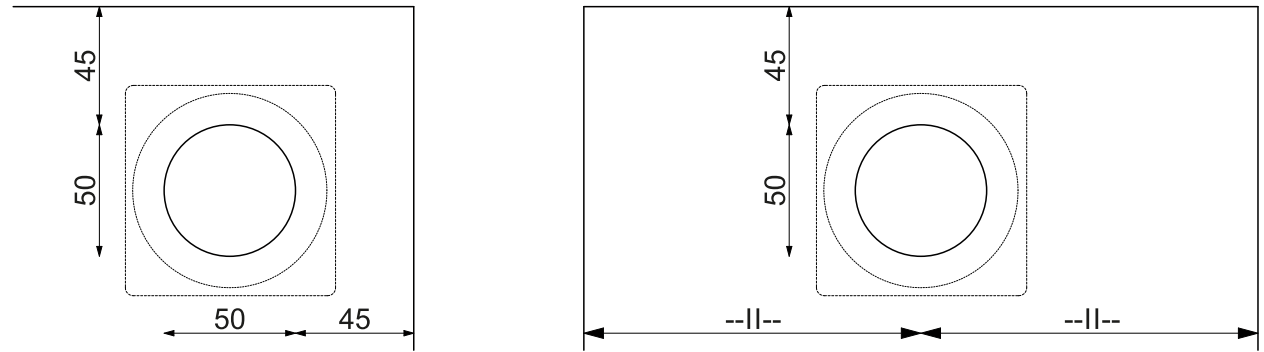

DETAIL\_HANDLE LOCATION

FLAT FRONT PANEL MADE OF  
MDF BOARD WITH MILLED  
HANDLE AND INSERT  
FINISHED WITH RAL / NCS  
PALETTE MATT LAQUER

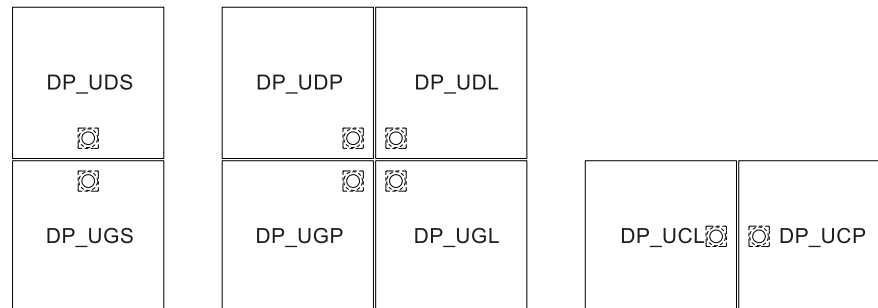

FRONT ASSEMBLING EXAMPLES



DN.n-000

SN.n-000

ON.n-000

ZK



HEIGHT: 96 - 2100  
WIDTH: 96 - 700

CS



HEIGHT 140 - 252  
WIDTH: 236 - 1000

CG



HEIGHT: 253 - 400  
WIDTH: 236 - 1000

DP\_UGP



HEIGHT: 401 - 2100  
WIDTH: 236 - 700

DP\_UGS



HEIGHT: 401 - 2100  
WIDTH: 236 - 700

DP\_UGL



HEIGHT: 401 - 2100  
WIDTH: 236 - 700

DP\_UDP



HEIGHT: 401 - 2100  
WIDTH: 236 - 700

DP\_UDS



HEIGHT: 401 - 2100  
WIDTH: 236 - 700

DP\_UDL



HEIGHT: 401 - 2100  
WIDTH: 236 - 700

DP\_UCP



HEIGHT: 401 - 2100  
WIDTH: 236 - 700

DP\_UCL



HEIGHT 401 - 2100  
WIDTH: 236 - 700

Model  
DS

VENEER/WOOD









If all you need is a quick makeover, then cabinet door replacement might be the great choice. Please refer to our online catalogue to pick the style and finish. In various styles, colour options, you will be spoilt for choice.



DN.n-000

DN.n-008

DN.b-009

DN.b-010

DN.b-017



DN.b-020

DN.b-040

DN.b-061

DN.b-062

DN.b\_070



DN.b-NCS

DN.b-099

SN.n-000

SN.b-040

SN.b-062



SN.b-063

SN.b-067

SN.b-070

SN.I-070

SN.b-099

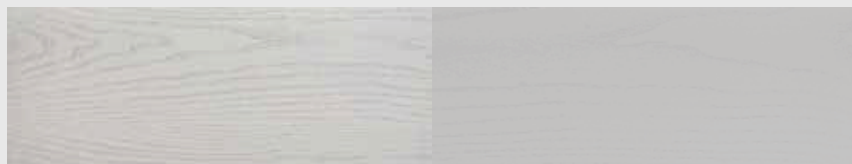

SN.b-NCS

SN.I-NCS

# DS

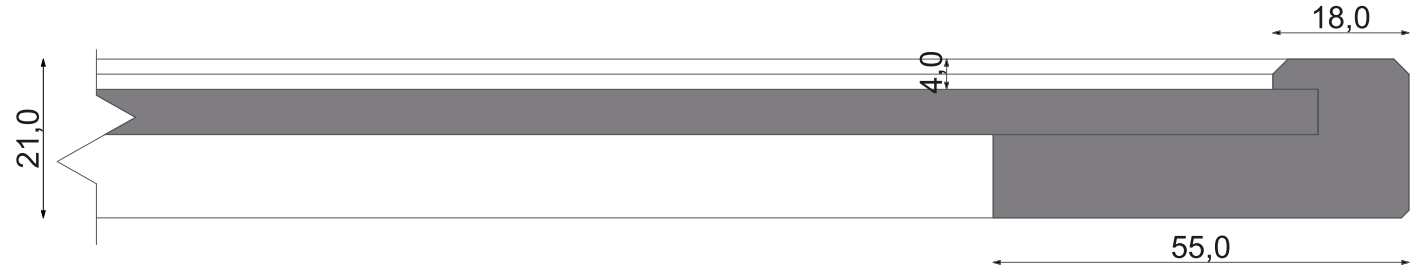

DETAIL \_ SECTION

FRAME FRONT MADE FROM  
WOOD / VENEERED MDF BOARD FINISHED WITH  
TRANSPARENT LAQUER WITH OPTIONAL  
STAINING WITH STAIN OR PIGMENT VARNISH

FOR COMPONENTS WITH DIMENSIONS GREATER THAN 1200mm, IT IS RECOMMENDED TO USE AN LEVELING MECHANISM

DS

TECHNICAL CARD

DR 2

ZK



HEIGHT: 96 - 1500  
WIDTH: 96 - 245

CS



HEIGHT: 96 - 252  
WIDTH: 96 - 1000

CG



HEIGHT: 253 - 400  
WIDTH: 250 - 1000

DR



HEIGHT: 401 - 1500  
WIDTH: 246 - 700



HEIGHT: 1501 - 2100  
WIDTH: 296 - 700

Model  
**DQ**

VENEER/WOOD







DN.n-000

DN.n-008

DN.b-009

DN.b-010

DN.b-017



DN.b-020

DN.b-040

DN.b-061

DN.b-062

DN.b\_070



DN.b-NCS

DN.b-099

SN.n-000

SN.b-040

SN.b-062



SN.b-063

SN.b-067

SN.b-070

SN.I-070

SN.b-099



SN.b-NCS

SN.I-NCS



# DQ

## TECHNICAL CARD

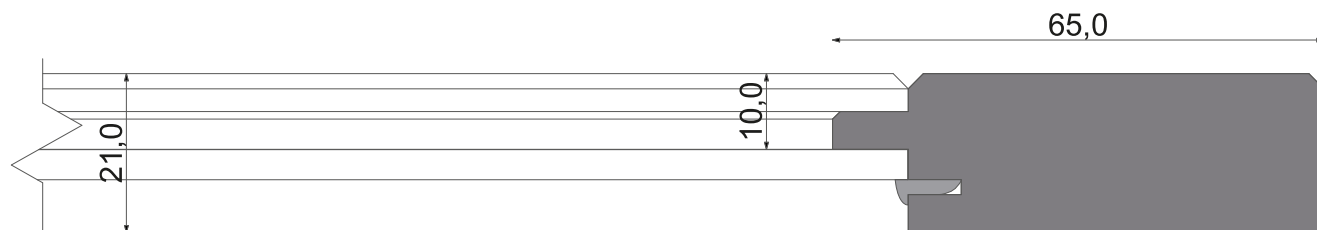

glass standard\_4mm

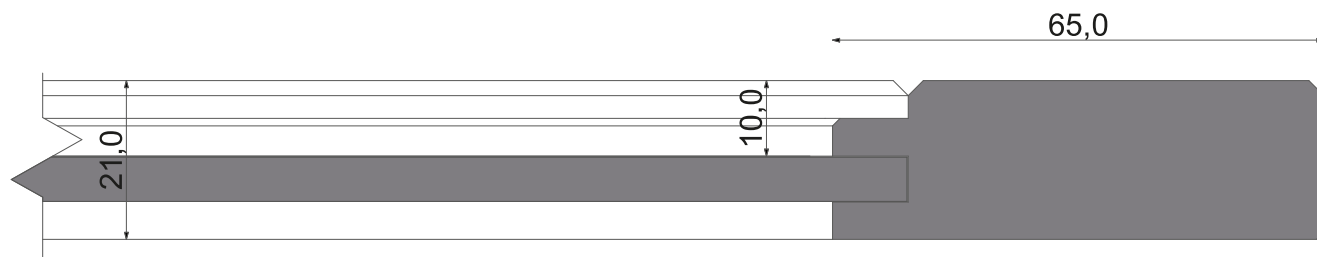

DETAIL \_ SECTION

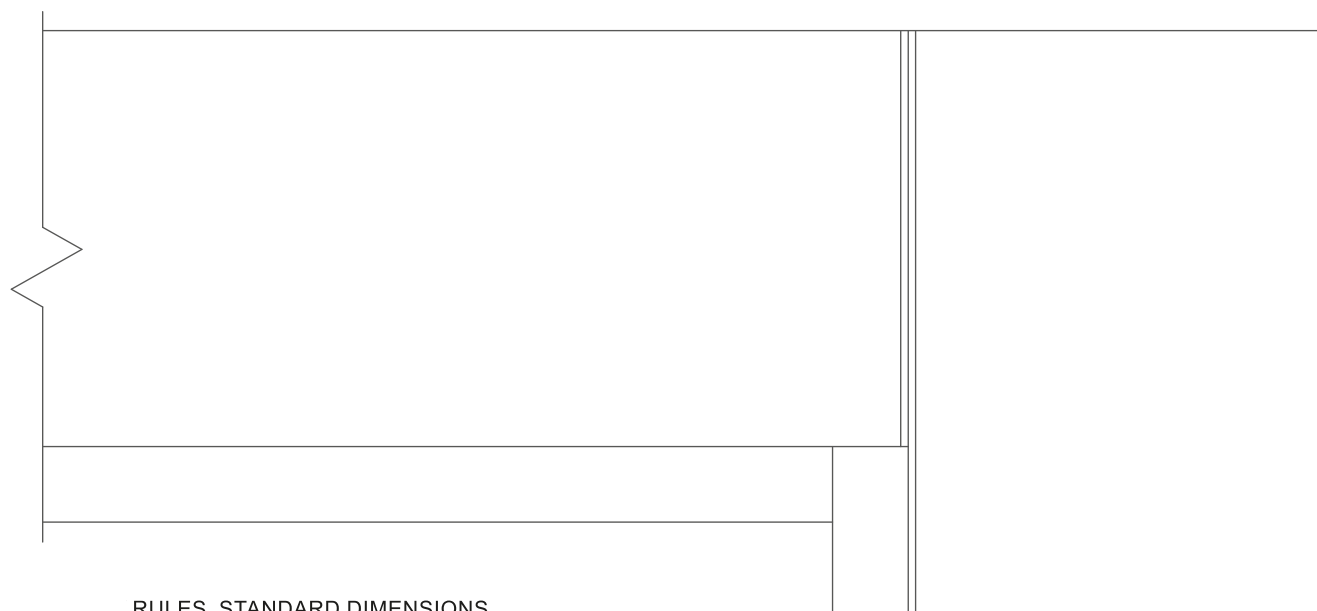

FRAME FRONT PANEL MADE OF WOOD AND VENEERED MDF BOARD FINISHED WITH TRANSPARENT MATT LAQUER WITH OPTIONAL STAINING WITH STAIN OR PIGMENT LAQUER

FOR COMPONENTS WITH DIMENSIONS GREATER THAN 1200mm, IT IS RECOMMENDED TO USE AN LEVELING MECHANISM

WO



HEIGHT: 401 - 1500  
WIDTH: 246 - 700

WO 2



HEIGHT: 1501 - 2100  
WIDTH: 296 - 700

DR 2



HEIGHT: 1501 - 2100  
WIDTH: 296 - 700

ZK



HEIGHT: 96 - 1500  
WIDTH: 96 - 245

Csp



HEIGHT: 96 - 252  
WIDTH: 96 - 1000

CG



HEIGHT: 253 - 400  
WIDTH: 246 - 1000

DR



HEIGHT: 401 - 1500  
WIDTH: 246 - 700

Model  
**SIMQ**

LACQUERED





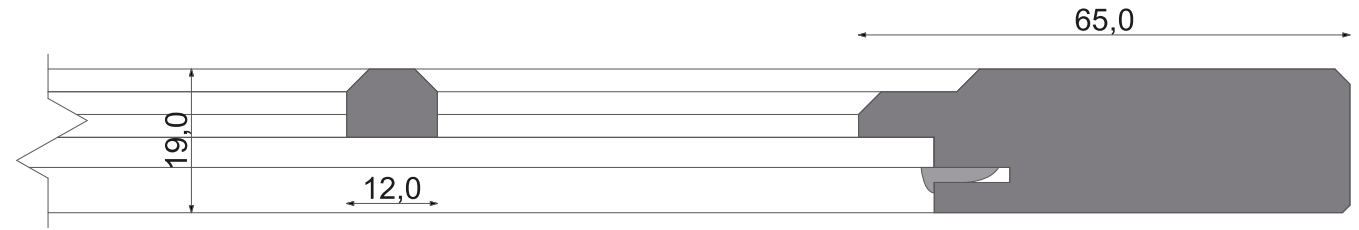

glass standard\_4mm



DETAIL \_ SECTION

FRAME FRONT PANEL MADE OF  
MDF BOARD FINISHED  
WITH RAL / NCS PALETTE  
MATT LAQUER

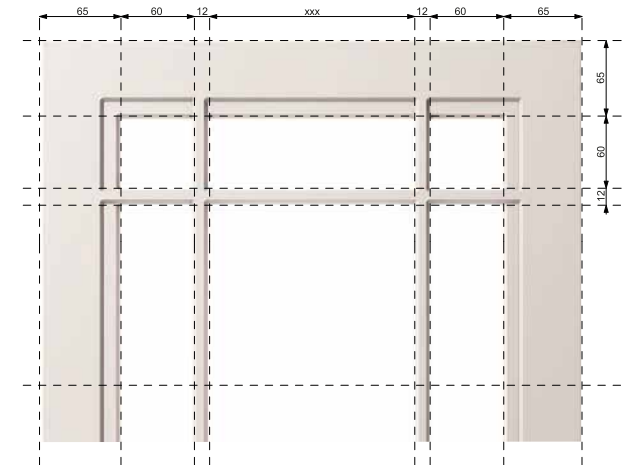
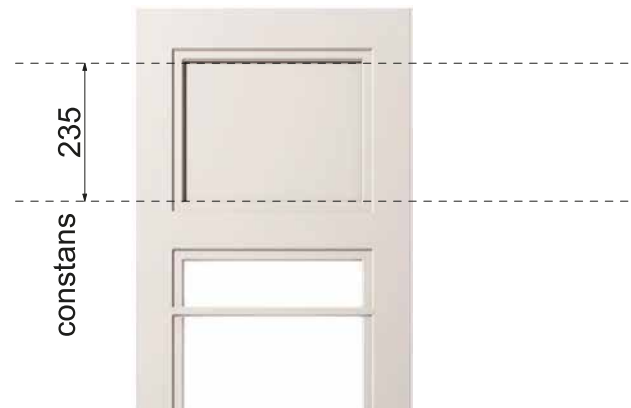

RULES\_STANDARD DIMENSIONS

FOR COMPONENTS WITH DIMENSIONS GREATER THAN 1200mm, IT IS RECOMMENDED TO USE AN LEVELING MECHANISM

WS -2/1



HEIGHT: 401 - 1500  
WIDTH: 296 - 700

WS -2/3



HEIGHT: 401 - 900  
WIDTH: 396 - 700

WS -3/3



HEIGHT: 600 - 1500  
WIDTH: 396 - 700

WD - O / S2



HEIGHT: 900 - 1800  
WIDTH: 296 - 700

WD - P / S2



HEIGHT: 900 - 1800  
WIDTH: 296 - 700

WO 2 - S2 / S2



HEIGHT: 1501 - 2400  
WIDTH: 296 - 700

CS



HEIGHT: 96 - 252  
WIDTH: 96 - 1000

CS d



HEIGHT: 96 - 252  
WIDTH: 96 - 1000

CS p



HEIGHT: 96 - 252  
WIDTH: 96 - 1000

WO 2



HEIGHT: 1501 - 2400  
WIDTH: 296 - 700

DR 2



HEIGHT: 1501 - 2400  
WIDTH: 296 - 700

ZK



HEIGHT: 96 - 2400  
WIDTH: 96 - 700

CG



HEIGHT: 253 - 400  
WIDTH: 246 - 1000

WO



HEIGHT: 401 - 1500  
WIDTH: 246 - 700

DR



HEIGHT: 401 - 1500  
WIDTH: 246 - 700

# WARDROBES

When it comes to beautifully designed and functional wardrobe space, you can be assured that we can manufacture and supply the best of the best.

Our wardrobe range can satisfy even the most sophisticated client. Select the style and finish and we will do the rest.

We supply wardrobes as in our catalogue or can design them based on your requirements.







# More space

inside your home



One of the best advantages of any bespoke furniture is gaining all that valuable storage.

If your wardrobes look outdated, then choose our option of cabinet door replacement.



# ACOUSTIC PANELS

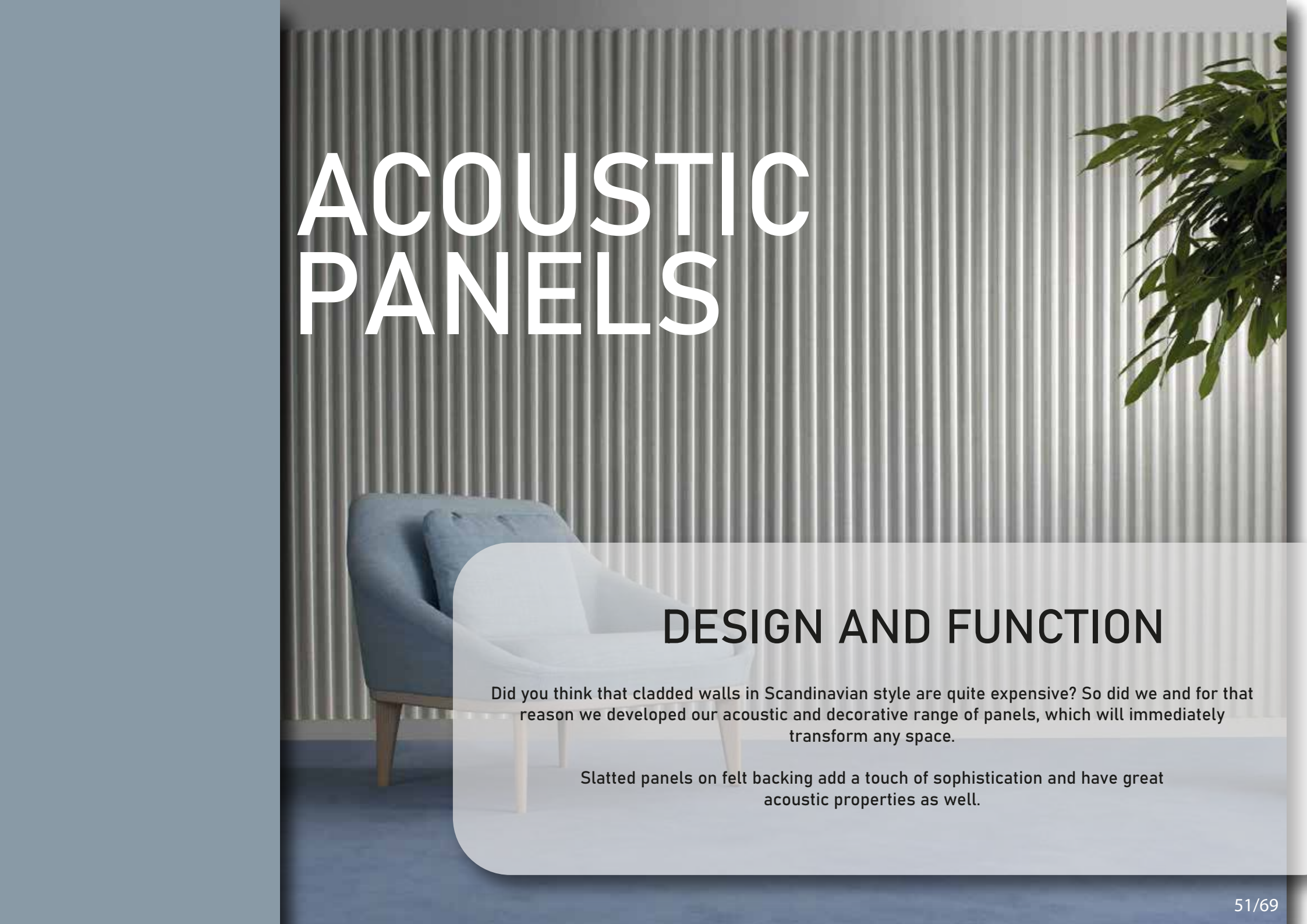

## DESIGN AND FUNCTION

Did you think that cladded walls in Scandinavian style are quite expensive? So did we and for that reason we developed our acoustic and decorative range of panels, which will immediately transform any space.

Slatted panels on felt backing add a touch of sophistication and have great acoustic properties as well.

# ELEGANT AND SOUNDPROOF

Our materials are carefully selected to ensure the outstanding quality of finished product.

Easy installation, eco friendly materials, budget friendly. Wood veneer options range from natural oak to walnut, with colour option such as black, dark grey, red or per your choice. Panels are suitable for domestic and commercial use.



# PERFECT MATERIALS HANDLED WITH PERFECTION

Our range of decorative panels is simply stunning and skilfully crafted.  
In various thickness and profiles depending on type of use.



Our panelling range is stylish and modern and if that isn't enough we also offer a selection of flexible panels, so creating curved features will not be an issue anymore.

# MATERIALS



Ebony Dark



Teak



Ebony Brown



Oak bright



American Walnut



Oak Light Grey



Oak Grey

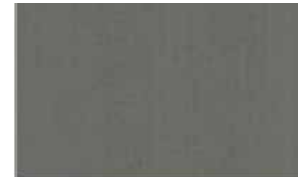

Oak white



# PROFILES







## ACOUSTIC AND DECORATIVE PANELS











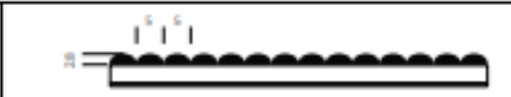



---

Suitable for walls and ceilings, our acoustic or decorative panels can convert any room into a stylish space very fast. The panels will come ready for an easy installation. Slatted panels on felt backing will transform the space and add a modern touch.

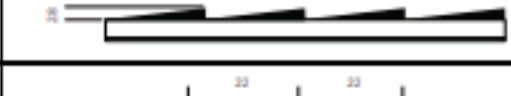
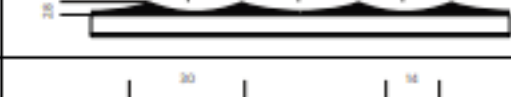



Our acoustic panels have high acoustic properties and are suitable for domestic or commercial use. We offer a wide range of Flexi panels, Solid panels, Bamboo panels and decorative panels created by innovative routing machinery to achieve chosen design.









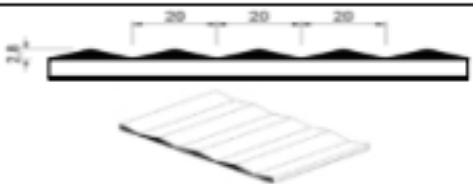
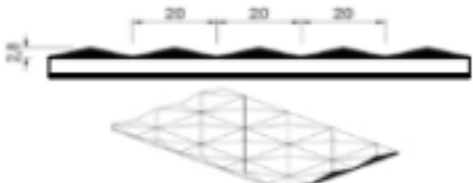



|             |  |       |
|-------------|--|-------|
| S3P5        |  | 3 mm  |
| S3P7,5      |  | 3 mm  |
| S3P10       |  | 3 mm  |
| S3P15       |  | 3 mm  |
| S3P20       |  | 3 mm  |
| S6P10       |  | 6 mm  |
| S6P13       |  | 6 mm  |
| S10P15      |  | 10 mm |
| WAVE P25    |  | 3 mm  |
| WAVE P22    |  | 3 mm  |
| WAVE P30    |  | 6 mm  |
| WAVE P8     |  | 6 mm  |
| WAVE P12/19 |  | 6 mm  |
| WAVE P20    |  | 6 mm  |
| WAVE P23.5  |  | 6 mm  |



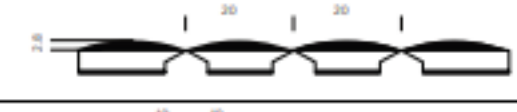



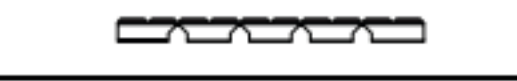

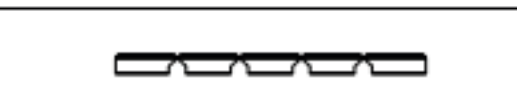

|             |                                                                                      |       |
|-------------|--------------------------------------------------------------------------------------|-------|
| S3P5        |      | 19 mm |
| S3P7,5      |    | 19 mm |
| S3P10       |    | 19 mm |
| S3P15       |    | 19 mm |
| S3P20       |    | 19 mm |
| S6P10       |    | 21 mm |
| S6P13       |    | 21 mm |
| S10P15      |    | 25 mm |
| WAVE P25    |    | 19 mm |
| WAVE P22    |  | 19 mm |
| WAVE P30    |  | 21 mm |
| WAVE P8     |  | 21 mm |
| WAVE P12/19 |  | 21 mm |
| WAVE P20    |  | 21 mm |
| WAVE P23.5  |  | 21 mm |

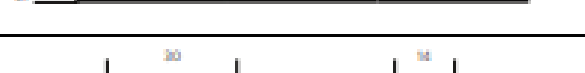

|                  |                                                                                   |      |
|------------------|-----------------------------------------------------------------------------------|------|
| WAVE PLUS        |    | 21mm |
| MILLED P4F04     |  | 21mm |
| MILLED P5F05     |  | 21mm |
| MILLED P6F06     |  | 21mm |
| MILLED P4/6/8/12 |  | 21mm |
| PYRAMID P20      |  | 19mm |
| DIAMOND P20      |  | 19mm |



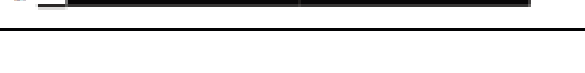







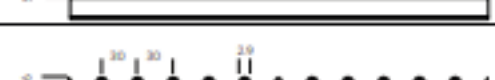
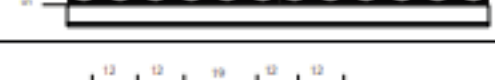

|        |                                                                                       |      |
|--------|---------------------------------------------------------------------------------------|------|
| S3P5   |       | 9mm  |
| S3P7,5 |     | 9mm  |
| S3P10  |    | 9mm  |
| S3P15  |    | 9mm  |
| S3P20  |    | 9mm  |
| S6P10  |    | 11mm |
| S6P13  |    | 11mm |
| S10P15 |    | 15mm |
| SIP10  |    | 9mm  |
| SIP15  |   | 9mm  |
| SIP20  |  | 9mm  |

|                                              |                                                                                    |      |
|----------------------------------------------|------------------------------------------------------------------------------------|------|
| S6P10                                        |    | 6 mm |
| S6P13                                        |   | 6 mm |
| WAVE P30                                     |  | 6 mm |
| WAVE P8                                      |  | 6 mm |
| WAVE P12/19                                  |  | 6 mm |
| WAVE P20                                     |  | 6 mm |
| WAVE P23.5                                   |  | 6 mm |
| WAVE PLUS                                    |  | 6 mm |
| MILLED P4F04<br>MILLED P5F05<br>MILLED P6F06 |  | 6 mm |
| MILLED P4/6/8/12                             |  | 6 mm |



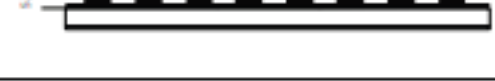

|                                              |                                                                                      |      |
|----------------------------------------------|--------------------------------------------------------------------------------------|------|
| S6P10                                        |     | 21mm |
| S6P13                                        |   | 21mm |
| WAVE P30                                     |   | 21mm |
| WAVE P8                                      |   | 21mm |
| WAVE P12/19                                  |   | 21mm |
| WAVE P20                                     |   | 21mm |
| WAVE P23.5                                   |   | 21mm |
| WAVE PLUS                                    |   | 21mm |
| MILLED P4F04<br>MILLED P5F05<br>MILLED P6F06 |   | 21mm |
| MILLED P4/6/8/12                             |   | 21mm |
| S6P10                                        |   | 11mm |
| S6P13                                        |  | 11mm |









# IRONMONGERY

## FIXTURES AND FITTINGS

You can order everything you need for  
cabinetry making right here.

We stock wide assortment of hinges,  
drawer slides and runners, lift systems,  
shelf supports and many more items.

You can place an order online or  
contact us for trade account.



We offer products from brands like Blum, Hettich, Strong, Gollinucci and many more.

Discounts available on large orders.





**FFA Ltd.**

**Unit 16**

Hampers Green

**Petworth**

**GU28 9NR**

Sales@theffa.co.uk

Info@theffa.co.uk

0800 246 5334

THE **FFA** Ltd.

Get in touch at [www.theffa.co.uk](http://www.theffa.co.uk) or call us on.....

We can offer discounts on bulk or repeat orders,  
so contact us to open a trade account with us.

Once you register, you can order everything you need under one roof,  
which will save you time  
and money.